



Self-Priming Centrifugal Pumps

# Installation & Operational Manual

Please reference this manual for the

## PH Series

# Table of Contents

Introduction	1
Recording Model and Serial Number	1
Warranty Information	2
Safety	2
Installation	6
Positioning Pump	7
Suction Lines	9
Automatic Air Release Valve	13
Alignment	16
Electrical Connections	19
Operation	20
Priming	20
Starting	21
Operation	21
Stopping	24
Bearing Temperature Check	25
Lubrication	25
Warranty Terms	27
Maintenance & Repair	28
Removals	29-31
Shaft & Bearing Removal & Disassembly	31
Seal Installation	38
Impeller Installation	42
Troubleshooting	49
Preventative Maintenance	51

## Introduction

Please read this manual carefully to learn how to safely install and operate your pump. Failure to do so could result in personal injury or damage to the pump.

If there you have any questions regarding the pump, which are not covered in this manual or in other literature accompanying the unit, please contact your Phantom distributor or contact us directly:

## Phantom Pumps



1550 Centennial Blvd.  
Bartow, FL 33830  
United States



+1 (888) 614-1232



## Recording Model and Serial Number

Please record the pump model and serial number in the spaces provided below. Your Phantom distributor needs this information when you require parts or services.

Pump Model: \_\_\_\_\_ Serial Number: \_\_\_\_\_

## Warranty Information

The warranty provided with your pump is part of Phantom Pumps support program for customers who operate and maintain their equipment as described in this and the other accompanying literature. Please note that should the equipment be abused or modified to change its performance beyond the original factory specifications, the warranty will become void and any claim will be denied.

## Safety

The following are used to alert personnel of procedures that require special attention—those that if performed incorrectly, could be dangerous to personnel and damage equipment:

### Alert



Please take precautions and pay special attention to these tasks, as they need to be conducted carefully.

### Alert Medium



Warning, these tasks are serious. Please follow the procedure carefully, as failure to do so could result in injury or damaged equipment.

### Alert High



These tasks are extremely serious and can result in **immediate hazards**, if done incorrectly, possibly leading to severe personal injury or death.

This information applies to Phantom Self-Priming Centrifugal pumps. These pumps are available as basic, pedestal-mounted models or as close-coupled models driven by an electric motor, gasoline, or diesel engine. Refer to the manual accompanying the power source before attempting to begin operation. This manual will alert personnel to known procedures which require special attention, to those which could damage equipment, and to those which could be dangerous to personnel. However, this manual cannot possibly anticipate and provide detailed instructions and precautions for every situation that might occur during the maintenance of the unit. Therefore, it is the responsibility of the owner /

maintenance personnel to ensure that only safe, established maintenance procedures are used and that any procedures not addressed in this manual are performed only after establishing that neither personal safety nor pump integrity is compromised by such practices.



### **Before attempting to open or service the pump:**

1. Familiarize yourself with this manual.
2. Disconnect or shut down the power source and take necessary precautions to ensure that the pump will remain inoperative.
3. Allow the pump to completely cool if overheated.
4. Check the temperature before opening any covers, plates, or plugs.
5. Close the suction and discharge valves.
6. Vent the pump slowly and cautiously.
7. Drain the pump.



### **Do's and don'ts**

**Don't** attempt to pump any liquids the pump has not been designed for which may damage the pump or endanger personnel as a result of pump failure.

Consult the factory to determine compatibility between the pump and liquid.

**Do** use lifting and moving equipment in good repair and with adequate capacity to prevent injuries to personnel or damage to equipment. Suction and discharge hoses and piping must be removed from the pump before lifting.

**Do** make certain that the pump and all piping or hose connections are tight, properly supported, and secure before operation after the pump has been positioned.

**Don't** operate the pump against a closed discharge valve for long periods of time. If operated against a closed discharge valve, pump components will deteriorate, and the liquid could

come to a boil, build pressure and cause the pump casing to rupture or explode.

**Don't** remove plates, covers, gauges, pipe plugs, or fittings from an overheated pump. Vapor pressure within the pump can cause parts to disengage and be ejected with great force. Allow the pump to cool before servicing.

**Do** use extreme caution when venting the pump, or when removing covers, plates, plugs, or fittings. These pumps may be used to handle products that if overheated could produce dangerous fumes.

**Don't** ever run this pump backward. Be certain that rotation is correct before fully engaging the pump.

**Do** limit direct exposure to emitted fumes or materials, by wearing protective clothing, such as rubber gloves, face mask, and rubber apron as necessary before disassembling the pump or piping to avoid serious illness or injury, especially if this pump is used to pump potentially hazardous materials.

**Don't** operate the pump without shields and/or guards in place over the drive shafts, belts, and/or couplings. Exposed rotating parts can catch clothing, fingers, or tools, causing severe injury to personnel.

**Don't** operate a non-explosion proof motor in an explosive atmosphere if the pump is powered by an electric motor. An explosion, which may cause severe personal injury or death, could result. Install, connect, and operate the motor in accordance with the National Electric Code and all local codes. If there is a conflict between the instructions in the manual accompanying the unit and the National Electric Code or applicable local code, the National or Local code shall take precedence. All electrical equipment supplied with the pump conforms to applicable federal regulations and national codes in effect on the date of manufacture.

**Do** obtain the services of a qualified electrician to troubleshoot, test, and/or service the

electrical components of the pump. If the pump is an electric motor driven, the electrical power used to operate this pump is high enough to cause injury or death.

**Do** be mindful that fuel used by internal combustion engines presents an extreme explosion and fire hazard. Make certain that all fuel lines are securely connected and free of leaks. Never refuel a hot or running engine. Avoid overfilling the fuel tank. Always use the correct type of fuel.

**Don't** ever tamper with the engine governor to gain more power. The governor establishes safe operating limits that should not be exceeded. The maximum continuous operating speed for the pump is shown on the performance curve.

**Do** know that if the pump is powered by an engine, the engine exhaust from this product contains chemicals known to cause cancer, birth defects other reproductive complications.



### **Do's and don'ts**

**Don't** ever operate in an explosive atmosphere if the pump is powered by an internal combustion engine. When operating internal combustion engines in an enclosed area, make certain that exhaust fumes are piped to the outside. These fumes contain carbon monoxide, a deadly gas that is colorless, tasteless, and odorless.

# Installation

Review all Safety information first

Since pump installations are seldom identical, this section offers only general recommendations and practices required to inspect, position, and arrange the pump and piping. Most of the information pertains to a standard static lift application where the pump is positioned above the free level of liquid to be pumped. If installed in a flooded suction application where the liquid is supplied to the pump under pressure, some of the information such as mounting, line configuration, and priming must be tailored to the specific application. Since the pressure supplied to the pump is critical to performance and safety, be sure to limit the incoming pressure to 50% of the maximum permissible operating pressure as shown on the pump performance curve.

For further assistance, contact your Phantom distributor.

## Pre-Installation Inspection

The pump assembly was inspected and tested before shipment from the factory. Before installation, inspect the pump for damage that may have occurred during shipment. Check as follows:

- Inspect the pump and power source (if so equipped) for cracks, dents, damaged threads, and obvious damage.
- Check for and tighten loose hardware. Since gaskets tend to shrink after drying, check for loose hardware at mating surfaces.
- Carefully read all tags and note pump shaft rotation. Check levels and lubricate as necessary.
- Refer to the Lubrication section of this manual and any other literature accompanying the unit and perform duties as instructed.
- If the pump and power source have been stored for more than 12 months, or if the maximum shelf life has been exceeded, contact your Phantom distributor or the factory to determine the repair or updating policy. Do not put the pump into service until appropriate



action has been taken.

## Battery Installation

If the pump is engine driven, the engine battery is not included with the unit unless otherwise specified on the pump order. Please refer to the battery tag included in the battery box assembly specifications.

## Positioning Pump

### Lifting

Use lifting equipment with a capacity of at least 5 times the weight of the pump, not including the weight of accessories. Customer-installed equipment such as suction and discharge piping must be removed before lifting.

The pump assembly can be seriously damaged if the chains or cables used to lift and move the unit are improperly wrapped around the pump.



### Mounting

Locate the pump in an accessible place as close as possible to the liquid being pumped. Level mounting is essential for proper operation. The pump may have to be supported or shimmed to provide for level operation or to eliminate vibration. If the pump has been mounted on a moveable base, make certain the base is stationary by setting the brake and blocking the wheels before attempting to operate the pump. If the pump is engine driven, do not position the pump and engine more than 15 degrees off horizontally for continuous operation in order to ensure sufficient lubrication and fuel supply to the engine. The pump and engine may be positioned up to 30 degrees off horizontally for intermittent operation only; however, the engine manufacturer should be consulted for continuous operation at angles greater than 15 degrees.

## **Clearance**

When positioning the pump, allow clearance in front of the back cover to permit removal of the cover and easy access to the pump interior. Consult the factory or the Specification Datasheet for recommended clearance.

## **Suction and Discharge Piping**

Pump performance is adversely affected by increased suction lift discharge elevation See the performance curve to be sure your overall application allows the pump to operate within the safe operation range.

## **Materials**

Pipe or hose may be used for suction and discharge line however, the materials must be compatible with the liquid being pumped. If the hose is used as the suction line it must be rigid-wall reinforced to prevent collapse under suction. Using pipe couplings in suction lines is not recommended.

## **Line configuration**

Keep suction and discharge lines as straight as possible to minimize friction losses. Make minimum use of elbows and fittings, which substantially increase friction loss. If elbows are necessary, use the long-radius type to minimize friction loss.

## **Connections to pump**

Before tightening a connecting flange, align it exactly with the pump port. Never pull a pipeline into place by tightening the flange bolts and/or couplings. Lines near the pump must be independently supported to avoid strain on the pump which could cause excessive vibration, decreased bearing life, and increased shaft and seal wear. If hose-type lines are used, they should have adequate support to secure them when filled with liquid and under pressure.

## **Gauges**

Most pumps are drilled and tapped for installing discharge pressure and vacuum suction gauges. If these gauges are desired for pumps that are not tapped, drill and tap the suction and discharge lines not less than 18 inches (457,2 mm ) from the suction and discharge ports. Installation closer to the pump may result in erratic readings.

## **Suction Lines**

To avoid air pockets that could affect pump priming, the suction line must be as short and direct as possible. When operation involves a suction lift, the line must always slope upward to the pump from the source of the liquid being pumped. If the line slopes down to the pump at any point along the suction run, air pockets will be created.

## **Fittings**

Suction lines should be the same size as the pump inlet. If reducers are used in suction lines, they should be the eccentric type and should be installed with the flat part of the reducer up to avoid creating air pockets. Valves are not normally used in suction lines, but if a valve is used install it with the stem horizontal to avoid air pockets.

## **Strainers**

If a strainer is furnished with a pump, be certain to use it. If not furnished with the pump but is installed by the pump user, make certain that the total area of the openings in the strainer is at least three or four times the cross-section of the suction line and that the openings will not permit passage of solids larger than the solids handling capability of the pump. Refer to the Specification Datasheet for the solids handling capability of your specific pump model.

## **Sealing**

Since even a slight leak will affect priming, head, and capacity especially when operating with a high suction lift, all connections in the suction line should be sealed with pipe dope to ensure an airtight seal. Follow the sealant manufacturer's recommendations when selecting and applying the pipe dope, it should be compatible with the liquid being pumped.

## Suction lines in sumps

If a single suction line is installed in a sump, it should be positioned away from the wall of the sump at a distance equal to 1-1/2 times the diameter of the suction line. If there is a liquid flow from an open pipe into the sump, the flow should be kept away from the suction inlet because the inflow will carry air down into the sump, and air entering the suction line will reduce pump efficiency. If it is necessary to position the inflow close to the suction inlet, install a baffle between the inflow and the suction inlet at a distance 1-1/2 times the diameter of the suction pipe. The baffle will allow entrained air to escape from the liquid before it is drawn into the suction inlet. If two suction lines are installed in a single sump, the flow paths may interact, reducing the efficiency of one or both pumps. To avoid this, position the suction inlets so that they are separated by a distance equal to at least 3 times the diameter of the suction pipe.

**Figure 1**

**Recommended Minimum Suction Line Submergence vs. Velocity**

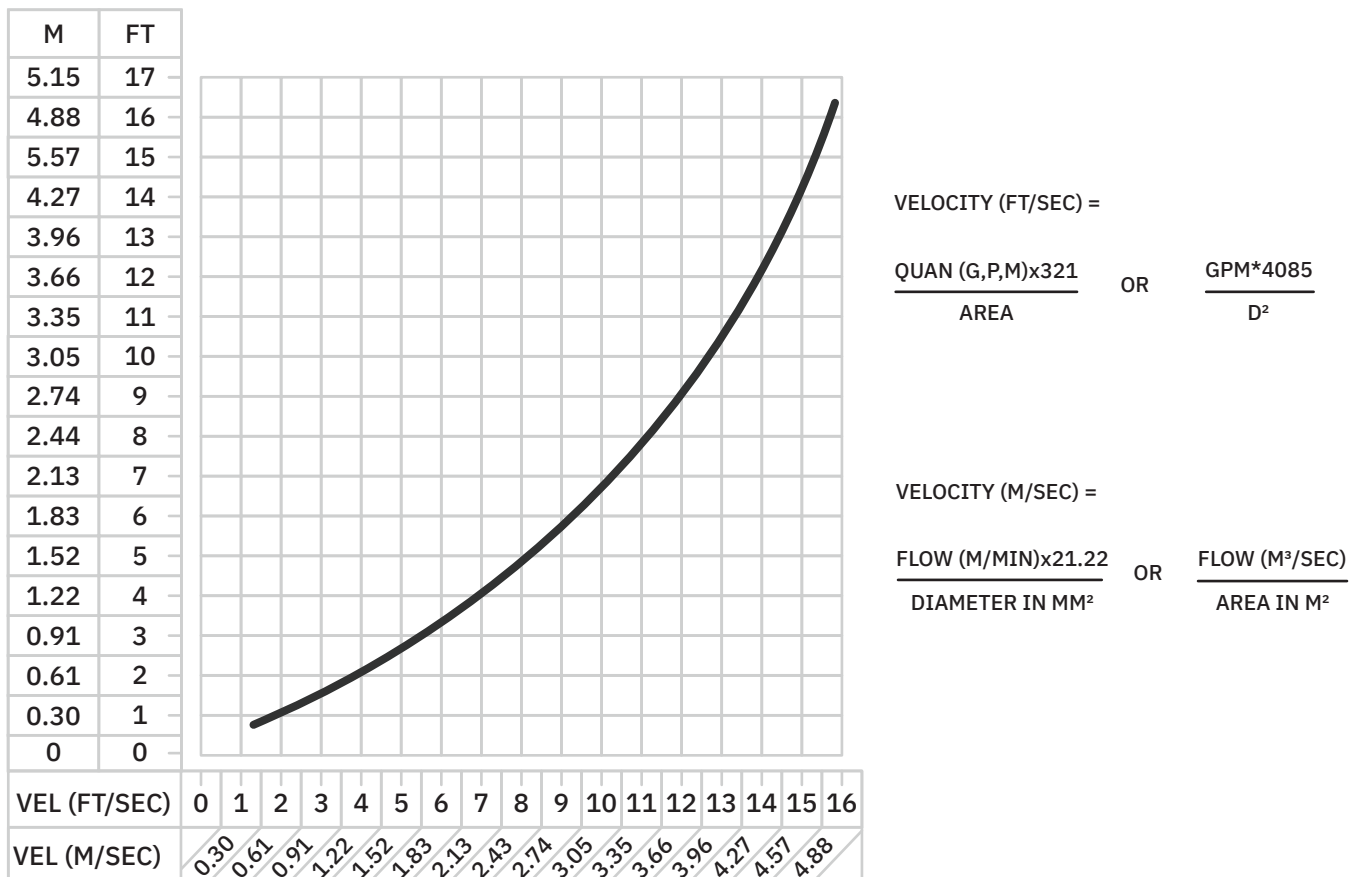

## Suction line positioning

The depth of submergence of the suction line is critical to efficient pump operation. **Figure 1** shows recommended minimum submergence vs. velocity.

### Note

The pipe submergence required may be reduced by installing a standard pipe increaser fitting at the end of the suction line. The larger opening size will reduce the inlet velocity. Calculate the required submergence using the following formula based on the increased opening size (area or diameter).

## Discharge Lines

### Siphoning

Do not terminate the discharge line at a level lower than that of the liquid being pumped unless a siphon breaker is used in the line. Otherwise, a siphoning action causing damage to the pump could result.



### Valves

If a throttling valve is desired in the discharge line, use a valve as large as the largest pipe to minimize friction losses. Never install a throttling valve in a suction line.

A check valve in the discharge line is normally recommended but not necessary in low-discharge head applications. With high discharge heads, it is recommended that a throttling valve and a system check valve be installed in the discharge line to protect the pump from excessive shock pressure and reverse rotation when it is stopped. If the application involves a high discharge head, gradually close the discharge throttling valve before stopping the pump.

### Bypass lines

Self-priming pumps are not air compressors. During the priming cycle, air from the suction line must be vented to the atmosphere on the discharge side. If the discharge line is open, this air will be vented through the discharge. However, if a check valve has been installed in the discharge line, the discharge side of the pump must be opened to atmospheric pressure

through a bypass line installed between the pump discharge and the check valve. A self-priming centrifugal pump will not prime if there is sufficient static liquid head to hold the discharge check valve closed.

## Note

The bypass line should be sized so that it does not affect pump discharge capacity; however, the bypass line should be at least 1 inch in diameter to minimize the chance of plugging.

### Low-discharge head application

In low-discharge head applications (less than 30 feet or 9 meters), it is recommended that the bypass line be run back to the wet well and located 6 inches below the water level or cut-off point of the low-level pump. In some installations, this bypass line may be terminated with a six-to-eight-foot length of 1 1/4 inch I.D. smooth-bore hose; air and liquid vented during the priming process will then agitate the hose and break up any solids, grease, or other substances likely to cause clogging. A bypass line that is returned to a wet well must be secured against being drawn into the pump suction inlet. It is also recommended that pipe unions be installed at each 90° elbow in a bypass line to ease disassembly and maintenance.

### High-discharge head application

In high-discharge head applications (more than 30 feet), an excessive amount of liquid may be bypassed and forced back to the wet well under the full working pressure of the pump, this will reduce overall pumping efficiency. Therefore, it is recommended that an Automatic Air Release Valve be installed in the bypass line. Automatic Air Release Valves are reliable and require minimum maintenance. See **Automatic Air Release Valve** in this section for installation and operation of the Automatic Air Release Valve. Consult your Phantom distributor for the selection of an Automatic Air Release Valve to fit your application. If the installation involves a flooded suction such as a below-ground lift station, a pipe union and manual shut-off valve may be installed in the bleed line to allow service of the valve without shutting down the station, and to eliminate the possibility of flooding. If a manual shut-off valve is installed **anywhere** in the air release piping, it must be a full-opening **ball type** valve

to prevent plugging by solids.



### Manual shut-off valve

If a manual shut-off valve is installed in a bypass line, it must not be left closed during operation. A closed manual shutoff valve may cause a pump that has lost its prime to continue to operate without reaching its prime, causing dangerous overheating and possible explosive rupture of the pump casing. Personnel could be severely injured.

Allow an overheated pump to cool before servicing. Do not remove plates, covers, gauges, or fittings from an overheated pump. The liquid within the pump can reach boiling temperatures and vapor pressure within the pump can cause parts to be disengaged and ejected with great force. After the pump cools, drain the liquid from the pump by removing the casing drain plug. Use caution when removing the plug to prevent injury to personnel from hot liquid.

### Automatic Air Release Valve

When properly installed and correctly adjusted to the specific hydraulic operating conditions of the application, the Automatic Air Release Valve will permit air to escape through the bypass line and then close automatically when the pump is fully primed and pumping at full capacity.

### Theory of operation

Figures 2 and 3 show a cross-sectional view of the Automatic Air Release Valve, and a corresponding description of the operation.

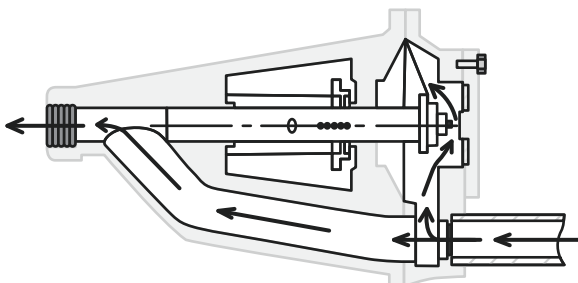

**Figure 2**

Valve In Open Position

During the priming cycle, air from the pump casing flows through the bypass line, and passes through the Air Release Valve to the wet well (**Figure 2**).

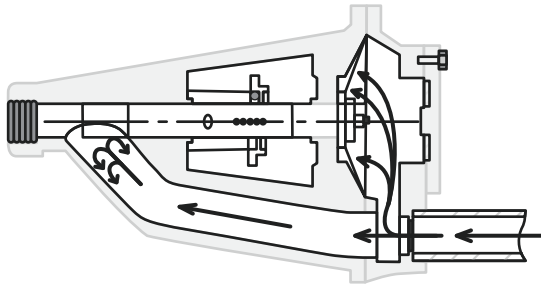

**Figure 3**

Valve In Closed Position

When the pump is fully primed, the pressure resulting from flow against the valve diaphragm compresses the spring and closes the valve (**Figure 3**). The valve will remain closed, reducing the bypass of liquid to 1 to 5 gallons (3.8 to 19 liters) per minute, until the pump loses its prime or stops.

When the pump shuts down, the spring returns the diaphragm to its original position. Any solids that may have accumulated in the diaphragm chamber settle to the bottom and are flushed out during the next priming cycle.



**Prevent hazardous spills**

Some leakage (1 to 5 gallons or 3.8 to 19 liters per minute) will occur when the valve is fully closed. Be sure the bypass line is directed back to the wet well or tank.

**Note**

The valve will remain open if the pump does not reach its designed capacity or head. Valve closing pressure is dependent upon the discharge head of the pump at full capacity. The range of the valve closing pressure is established by the tension rate of the spring as ordered from the factory. Valve closing pressure can be further adjusted to the exact system requirements by moving the spring retaining pin up or down the plunger rod to increase or decrease tension on the spring. Contact your Phantom distributor or Arroyo Process for information about an Automatic Air Release Valve for your specific application.



**Figure 4**

**Typical Automatic Air Release Valve Installation**

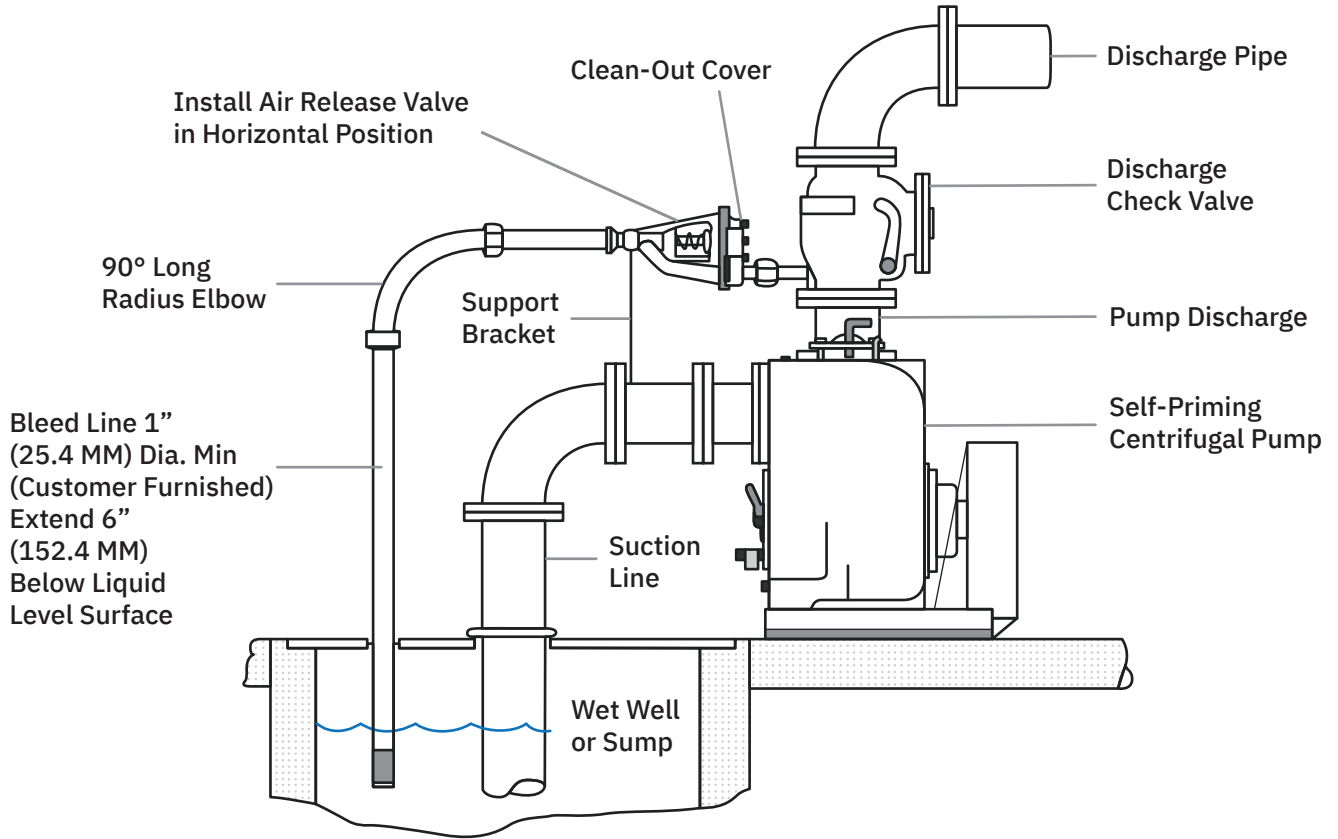

**Air release valve installation**

The Automatic Air Release Valve must be independently mounted in a horizontal position and connected to the discharge line of the self-priming centrifugal pump (see Figure 4).

The valve inlet line must be installed between the pump discharge port and the non-pressurized side of the discharge check valve. The valve inlet is at the large end of the valve body and is provided with standard 1-inch NPT pipe threads.

The valve outlet is located at the opposite end of the valve and is also equipped with standard 1-inch NPT pipe threads. The outlet should be connected to a bleed line that slopes back to the wet well or sump. The bleed line must be the same size as the inlet piping or larger. If piping is used for the bleed line, avoid the use of elbows whenever possible.

## Note

If the Air Release Valve is to be installed on a staged pump application, contact the factory for specific installation instructions.

## Alignment

The alignment of the pump and its power source is critical for trouble-free mechanical operation. In either a flexible coupling or V-belt driven system, the driver and pump must be mounted so that their shafts are aligned with and parallel to each other. When mounted at the factory, the driver and pump are aligned before shipment. Misalignment will occur in transit and handling. Pumps must be checked and realigned if necessary before start-up. Before checking alignment, tighten the foundation bolts. The pump casing feet and/or pedestal feet. the driver mounting bolts should also be tightly secured.



### Disconnect power source

When checking alignment, it's important to disconnect the power source to ensure that the pump will remain inoperative.



### Adjusting alignment

Adjusting the alignment in one direction may alter the alignment in another direction. Check each procedure after altering alignment.



### Final alignment check

It's imperative that the alignment is checked after the pump and piping are installed before operation. Check Rotation, Section C, before the final alignment of the pump.

## Coupled drives

When using couplings, the axis of the power source must be aligned to the axis of the pump shaft in both the horizontal and vertical planes. Most couplings require a specific gap or

clearance between the driving and the driven shafts. Refer to the coupling manufacturer's service literature.

Align spider insert type couplings by using calipers to measure the dimensions on the circumference of the outer ends of the coupling hub every 90 degrees. The coupling is in alignment when the hub ends are the same distance apart at all points (see Figure 5).

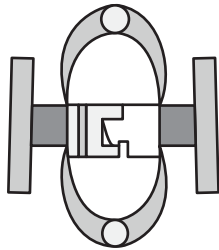

**Figure 5**

### Aligning Spider-Type Couplings

Align non-spider type couplings by using a feeler gauge or taper gauge between the coupling halves every 90 degrees. The coupling is in alignment when the hubs are the same distance apart at all points (see Figure 6).

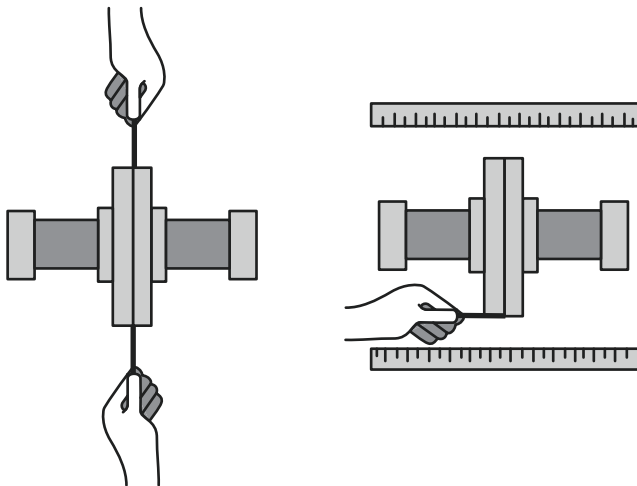

**Figure 6**

### Aligning Non-Spider Type Couplings

Check parallel adjustment by laying a straightedge across both coupling rims at the top, bottom, and side. When the straightedge rests evenly on both halves of the coupling, the coupling is in horizontal parallel alignment. If the coupling is misaligned, use a feeler gauge between the coupling and the straightedge to measure the amount of misalignment.

## V-belt drives

When using V-belt drives, the power source and the pump must be parallel. Use a straight-edge along the sides of the pulleys to ensure that the pulleys are properly aligned (see **Figure 7**). In drive systems using two or more belts, make certain that the belts are a matched set; unmatched sets will cause accelerated belt wear.

Tighten the belts in accordance with the belt manufacturer’s instructions. If the belts are too loose, they will slip; if the belts are too tight, there will be excessive power loss and possible bearing failure. Select pulleys that will match the proper speed ratio; over speeding the pump may damage both pump and power source.

**Figure 7**

### Alignment of V-Belt Driven Pumps

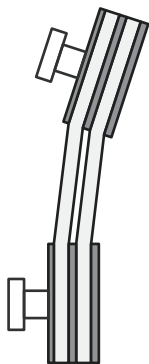

**Misaligned:**  
Shafts Not Parallel

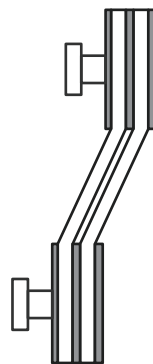

**Misaligned:**  
Shafts Not In Line



**Aligned: Shafts Parallel  
& Sheaves In Line**



**Never operate the pump without the guard**

Exposed rotating parts can catch clothing, fingers, or tools, causing severe injury to personnel. Do not operate the pump without the guard in place over the rotating parts.

## Electrical Connections

If the pump is driven by an electric motor, check that the electrical service available matches the motor requirements stamped on the motor nameplate before connecting a motor to the incoming power. Check that the motor speed meets pump specifications.

If rotation is incorrect on a three-phase motor, have a qualified electrician interchange any two of the three phase wires to change direction. If rotation is incorrect on a single-phase motor, consult the literaturesupplied with the motor for specific instructions.



### **Always work with an electrician**

The electrical power used to operate the pump is high enough to cause injury or death. Obtain the services of a qualified electrician to make all electrical connections.



### **Never operate in an explosive atmosphere**

If the pump is powered by an electric motor, do not operate a non-explosion proof motor in an explosive atmosphere. An explosion, which may cause severe personal injury or death, could result. Install, connect, and operate the motor in accordance with the National Electric Code and all local codes. If there is a conflict between the instructions in the manual accompanying the unit and the National Electric Code or applicable local code, the National or Local code shall take precedence. All electrical equipment supplied with the pump conforms to applicable federal regulations and national codes in effect on the date of manufacture.

# Operation

Review all Safety information first

Follow the instructions on all tags, labels and decals attached to the pump.



## Types of fluid handling

Do not attempt to pump any liquids the pump has not been designed for and which may damage the pump or endanger personnel as a result of pump failure.



## Pump speed

Pump speed and operating conditions must be within the performance range shown on the curve. Refer to the pump Datasheet for the specific performance for your pump.

## Priming

Install the pump and piping as described in **INSTALLATION**. Make sure that the piping connections are tight, and that the pump is securely mounted. Check that the pump is properly lubricated (see the **Lubrication** section in the manual).

To fill the pump, remove the pump casing, fill cover or fill plug in the top of the casing and add clean liquid until the casing is filled. Replace the fill cover or fill plug before operating the pump. Once the pump casing has been filled, the pump will prime and reprime as necessary.



## Add liquid to the pump casing when:

1. The pump is being put into service for the first time.
2. The pump has not been used for a considerable length of time.
3. The liquid in the pump casing has evaporated.



## **Don't operate your pump when dry**

The pump is self-priming, but it should never be operated unless there is liquid in the pump casing. The pump will not prime when dry. Extended operation of a dry pump will destroy the seal assembly.



## **Always check that all piping is secure**

After filling the pump casing, reinstall and tighten the fill plug. Do not attempt to operate the pump unless all connecting piping is securely installed. Otherwise, liquid in the pump forced out under pressure could cause injury to personnel.

## **Starting**

Starting procedures will vary slightly depending on the pump application, type of priming device and type of drive. Consult the operations manual furnished with the power source.



## **Rotation**

The pump must operate in the direction indicated by the arrow on the pump, or accompanying decals. Reverse rotation could loosen the impeller and seriously damage the pump. If the pump is driven by an electric motor, consult the operating manual furnished with the motor before attempting to start the motor.

If rotation is incorrect on a three-phase motor, have a qualified electrician interchange any two of the three phase wires to change direction. If rotation is incorrect on a single-phase motor, consult the literature supplied with the motor for specific instructions.

## **Operation**

Pump speed and operating points must be within the continuous performance range shown on the pump curve. (See the Parts List accompanying the pump.)



## **Lines with a bypass**

Close the discharge throttling valve (if so equipped) so that the pump will not have to prime against the weight of the liquid in the discharge line. Air from the suction line will be discharged through the bypass line back to the wet well during the priming cycle. When the pump is fully primed and liquid is flowing steadily from the bypass line, open the discharge throttling valve. Liquid will then continue to circulate through the bypass line while the pump is in operation.

## **Lines without a bypass**

Open all valves in the discharge line and start the power source. Priming is indicated by a positive reading on the discharge pressure gauge or by a quieter operation. The pump may not prime immediately because the suction line must first fill with liquid. If the pump fails to prime within five minutes, stop it and check the suction line for leaks. After the pump has been primed, partially close the discharge line throttling valve in order to fill the line slowly and guard against excessive shock pressure which could damage pipe ends, gaskets, sprinkler heads, and any other fixtures connected to the line. When the discharge line is completely filled, adjust the throttling valve to the required flow rate.



## **Avoid using against a closed discharge throttling valve**

Do not operate the pump against a closed discharge throttling valve for long periods of time. If operated against a closed discharge throttling valve, pump components will deteriorate, and the liquid could come to a boil, build pressure, and cause the pump casing to rupture or explode.

## **Leakage**

No leakage should be visible at pump mating surfaces, connections or fittings. Keep all line connections and fittings tight to maintain maximum pump efficiency.



## Liquid temperature and overheating

Refer to the Specification Datasheet for the maximum liquid temperature for your specific pump. Do not apply the pump at a higher operating temperature. Overheating can occur if operated with the valves in the suction or discharge lines closed. Operating against closed valves could bring the liquid to a boil, build pressure and cause the pump to rupture or explode. If overheating occurs, stop the pump and allow it to cool before servicing it. Refill the pump casing with cool liquid.

If overheating does occur, stop the pump immediately and allow it to cool before servicing it. Approach any overheated pump cautiously. As a safeguard against rupture or explosion due to heat are equipped with a pressure relief valve which will open if vapor pressure within the pump casing reaches a critical point. It's recommended that the pressure relief valve assembly be replaced at each overhaul, or any time the pump casing overheats and activates the valve.



### **Never try to service a hot pump**

Allow an over-heated pump to completely cool before servicing. Do not remove plates, covers, gauges, or fittings from an over-heated pump. Liquid within the pump can reach boiling temperatures and vapor pressure within the pump can cause parts being disengaged to be ejected with great force. After the pump cools, drain the liquid by removing the casing drain plug. Use caution when removing the plug to prevent injury to personnel from hot liquid.

## Strainer check

If a suction strainer is installed check the strainer regularly, and clean it as necessary. The strainer should also be checked if pump flow rate begins to drop. If a vacuum/suction gauge has been installed monitor and record the readings regularly to detect strainer blockage. Never introduce air or steam pressure into the pump casing or piping to remove a blockage. This could result in personal injury or damage to the equipment. If back flushing is absolutely necessary, liquid pressure must be limited to 50% of the maximum permissible operating pressure shown on the pump performance curve.

## Pump vacuum check

With the pump inoperative, install a vacuum gauge in the system, using pipe dope on the threads. Block the suction line and start the pump. At operating speed the pump should pull a vacuum of 20 inches (508 mm) or more of mercury. If it does not, check for air leaks in the seal, gasket, or discharge valve. Open the suction line and read the vacuum gauge with the pump primed and at operation speed. Shut off the pump. The vacuum gauge reading will immediately drop proportionate to static suction lift and should then stabilize. If the vacuum reading falls off rapidly after stabilization an air leak exists. Before checking for the source of the leak, check the point of installation of the vacuum gauge.

## Operational checks

Check the pump for proper operation when it is first started and periodically thereafter to identify minor problems. Check the pump for unusual noises or excessive vibration while it is operating. If noise or vibration is excessive, stop the pump and refer to troubleshooting for possible causes.



### Stopping

Never halt the flow of liquid suddenly. If the liquid being pumped is stopped abruptly, damaging shock waves can be transmitted to the pump and piping system. Close all connecting valves slowly. On engine driven pumps, reduce the throttle speed slowly and allow the engine to idle briefly before stopping.

If the application involves a high discharge head, gradually close the discharge throttling valve before stopping the pump.



### Disconnect power source

After stopping the pump, lock out or disconnect the power source to ensure that the pump will remain inoperative.

## **Cold weather preservation**

In below freezing conditions, drain the pump to prevent damage from freezing. Also, clean out any solids by flushing with a hose. Operate the pump for approximately one minute; this will remove any remaining liquid that could freeze the pump rotating parts. If the pump will be idle for more than a few hours or if it has been pumping liquids containing a large amount of solids, drain the pump and flush it thoroughly with clean water. To prevent large solids from clogging the drain port and preventing the pump from completely draining, insert a rod or stiff wire into the drain port and agitate the liquid during the draining process. Clean out any remaining solids by flushing with a hose.

## **Bearing temperature check**

Bearings normally run at higher than ambient temperatures because of heat generated by friction. Temperatures up to 160°F (71°C) are considered normal for bearings, and they can operate safely to at least 180°F (82°C).

Checking bearing temperatures by hand is inaccurate. Bearing temperatures can be measured accurately by placing a contact type thermometer against the housing. Record this temperature for future reference. A sudden increase in bearing temperature is a warning that the bearings are at the point of failing to operate properly. Make certain that the bearing lubricant is of the proper viscosity and at the correct level (see Lubrication section in the manual). Bearing overheating can also be caused by shaft misalignment and/or excessive vibration.

When pumps are first started, the bearings may seem to run at temperatures above normal. Continued operation should bring the temperatures down to normal levels.

## **Lubrication**

On a new pump check the oil level before initial startup, after the first two weeks of operation and every month thereafter. Before installing or removing the lubrication plug always clean the area around the plug to prevent contamination.

## **Self-lubricated seal assembly**

The self-lubricated seal assembly is lubricated by the media being pumped, or by a flow of fresh liquid from an external source. Flushing liquid may be taken from the pump discharge and supplied through auxiliary piping. When handling abrasive or tacky liquids, supply fresh lubricating liquid from an external source. Be sure the liquid supplied to the seal is compatible with the liquid being pumped and that its flow is controlled to prevent dilution. Consult the factory if flushing is required.

## **Oil-lubricated seal assembly**

Before starting the pump remove the vented plug and fill the seal cavity with SAE No. 30 non-detergent oil. Clean and reinstall the vented plug. Refer to the Maintenance and Repair Manual for the seal cavity oil capacity.

### **Note**

There are 2 fill plugs one is for the bearings and one is for the seal. The bearings have a vent plug and the seal has a standard pipe plug. Do not change the seal and put oil in the bearing housing, this will cause a damage to the equipment.

## **Oil-lubricated bearings**

Bearing housings are not filled with oil when shipped from the factory. Use SAE No. 30 non-detergent oil. Do not over-lubricate. Over-lubrication can cause the bearings to over-heat, resulting in premature bearing failure.

Under normal conditions, drain the bearing housing once each year and refill with clean oil. Change the oil more frequently if the pump is operated continuously or installed in an environment with rapid temperature change.

Monitor the condition of the bearing lubricant regularly for evidence of rust or moisture condensation. This is especially important in areas where variable hot and cold temperatures are common.

For cold weather operation, consult the factory or a lubricant supplier for the recommended grade of oil.

## Warranty

Pumping units manufactured by Phantom Pumps, are guaranteed to be free from defects in material and workmanship for one year from date of shipment from the Bartow, Florida facility. The obligation under this Warranty, statutory or otherwise, is limited to replacement or repair in Bartow, Florida or at a point designated by Phantom Pumps, of such part as shall appear to us upon inspection at such point, to have been defective in material or workmanship.

This Warranty does not obligate Phantom Pumps to bear the cost of labor or transportation charges in connection with replacement or repair of defective parts; nor shall it apply to a pump upon which repairs or alterations have been made unless authorized by Phantom Pumps.

No warranty is made in respect to engines, motors, or trade accessories, such being subject to warranties of their respective manufacturers.

Since the motor is subject to an important degree upon quality and performance of electrical controls, unit warranty is valid only when controls have been specified and provided by Phantom Pumps.

No express implied or statutory warranty, other than herein set forth is made or authorized to be made by Phantom Pumps.

In no event shall Phantom Pumps be liable for consequential damages or contingent liabilities arising out of the failure of any Phantom pump or parts thereof to operate properly.

**Phantom Pumps**

Bartow, Florida

# Maintenance & Repair

## Pump & Seal Disassembly & Reassembly

Follow the instructions on all tags, label and decals attached to the pump.

This pump requires little service due to its rugged, minimum-maintenance design. However, if it becomes necessary to inspect or replace the wearing parts, follow these instructions which are keyed to the sectional views (see Figures 1 and 2) and the accompanying parts lists.

As described on the following pages, this manual will alert personnel to known procedures which require special attention, to those which could damage equipment, and to those which could be dangerous to personnel. However, this manual cannot possibly anticipate and provide detailed precautions for every situation that might occur during maintenance of the unit. Therefore, it is the responsibility of the owner/maintenance personnel to ensure that only safe, established maintenance procedures are used, and that any procedures not addressed in this manual are performed only after establishing that neither personal safety nor pump integrity are compromised by such practices.

Many service functions may be performed by draining the pump and removing the back cover assembly. If major repair is required, the piping and/or power source must be disconnected. The following instructions assume complete disassembly is required.

Before attempting to service the pump, disconnect or lock out the power source and take precautions to ensure that it will remain inoperative. Close all valves in the suction and discharge lines.

For power source disassembly and repair, consult the literature supplied with the power source, or contact your local power source representative.



### **Before attempting to open or service the pump:**

1. Familiarize yourself with this manual.
2. Disconnect or lock out the power source to ensure that the pump will remain inoperative.
3. Allow the pump to completely cool if overheated.
4. Check the temperature before opening any covers, plates, or plugs.
5. Close the suction and discharge valves.
6. Vent the pump slowly and cautiously.
7. Drain the pump.



### **Always use proper lifting and moving equipment**

Use lifting and moving equipment in good repair and with adequate capacity to prevent injuries to personnel or damage to equipment.

## **Back cover & wear plate removal**

The wear plate is easily accessible and may be serviced by removing the back cover assembly. Before attempting to service the pump, remove the pump casing drain plug and drain the pump. Clean and reinstall the drain plug. Remove the hand nuts and pry the back cover and assembled wear plate from the pump casing.

Inspect the wear plate, and replace it if badly scored or worn. To remove the wear plate, disengage the hardware. Inspect the back cover O-rings and replace it if damaged or worn.

### **Note**

An alternate method of removing the back cover from the pump casing is to remove the hand nuts and two diagonally opposing locking collars. Install two 1/2-16 UNC x 2 inch long screws in the tapped holes in the back cover and use them to press the back cover out of the pump casing.

## Suction check valve removal

If the check valve assembly is to be serviced, remove the check valve pin, reach through the back cover opening and pull the complete assembly from the suction flange.

### Note

Further disassembly of the check valve is not required since it must be replaced as a complete unit. Individual parts are not sold separately.

## Rotating assembly removal

The rotating assembly may be serviced without disconnecting the suction or discharge piping; however, the power source must be removed to provide clearance.

The impeller should be loosened while the rotating assembly is still secured to the pump casing. Before loosening the impeller, remove the seal cavity drain plug and drain the seal lubricant. This will prevent the oil in the seal cavity from escaping when the impeller is loosened. Clean and reinstall the seal cavity drain plug.

Immobilize the impeller by wedging a block wood between the vanes and the pump casing, and remove the impeller capscrew and washer.

Install the shaft key. Install a lathe dog on the drive end of the shaft with the 'V' notch positioned over the shaft key.

With the impeller rotation still blocked, see **Figure 8** and use a long piece of heavy bar stock to pry against the arm of the lathe dog in a counterclock wise direction (when facing the drive end of the shaft). Use caution not to damage the shaft or key way. When the impeller breaks loose, remove the lathe dog, key and wood block.

### Note

Do not remove the impeller until the rotating assembly has been successfully removed from the pump casing.



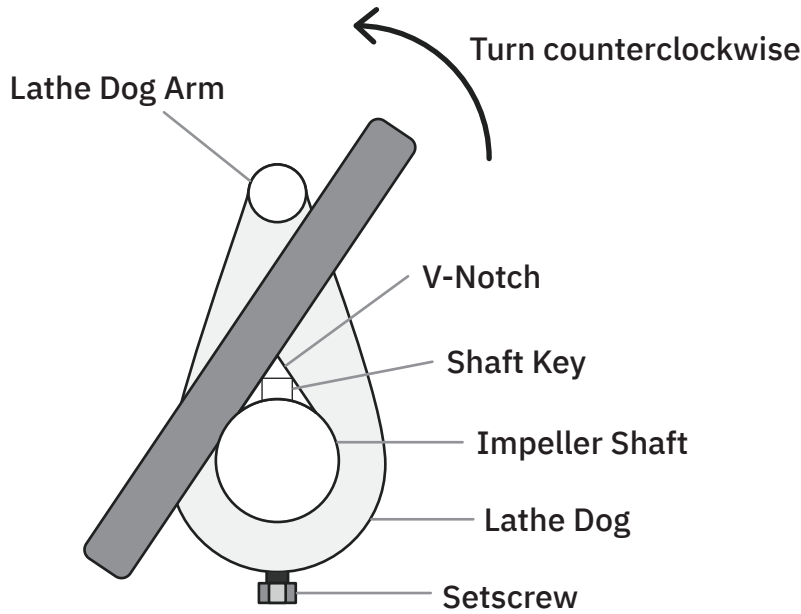

**Figure 8**

**Loosening Impeller**

Remove the hardware securing the rotating assembly to the pump casing. Separate the rotating assembly by pulling straight away from the pump casing. Tie and tag the rotating assembly shims for ease of reassembly.

**Note**

An optional disassembly tool is available from the factory. If the tool is used, follow the instructions packed with it. A similar tool may be assembled using 1/2-inch pipe (schedule 80 steel or malleable iron) and a standard tee (see Figure 9). All threads are 1/2-inch NPT.

**Do not pre-assemble the tool.**

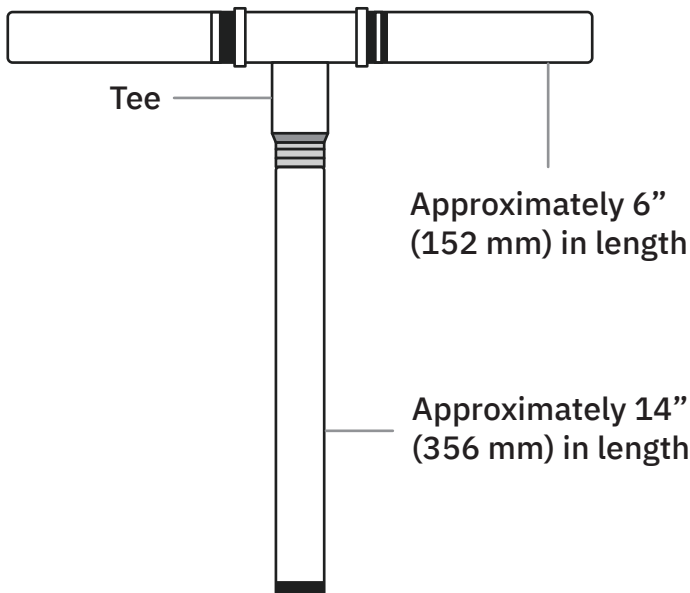

**Figure 9**

**Rotating Assembly Tool**

To install the tool, remove the vented plug from the bearing housing, and screw the longest length of pipe into the vent hole until fully engaged. Install the tee, and screw the handles into the tee. Use caution when lifting the rotating assembly to avoid injury to personnel or damage to the assembly.

Remove the bearing housing O-ring.

## **Impeller removal**

With the rotating assembly removed from the pump casing, unscrew the impeller from the shaft. Use caution when unscrewing the impeller; tension on the shaft seal spring will be released as the impeller is removed. Inspect the impeller and replace if cracked or badly worn.

Remove the impeller adjusting shims; tie and tag the shims, or measure and record their thickness for ease of reassembly.

## **Seal removal**

Slide the integral shaft sleeve and rotating portion of the seal off the shaft as a unit. Use a pair of stiff wires with hooked ends to remove the stationary element and seat.

An alternate method of removing the stationary seal components is to remove the hardware and separate the seal plate and gasket from the bearing housing. Position the seal plate on a flat surface with the impeller side down. Use a wooden dowel or other suitable tool to press on the back side of the stationary seat until the seal, O-rings, and stationary element can be removed.

Remove the shaft sleeve O-ring. If no further disassembly is required, refer to **Seal Installation**.

## **Shaft & bearing removal & disassembly**

When the pump is properly operated and maintained, the bearing housing should not require disassembly. Disassemble the shaft and bearings only when there is evidence of wear or damage.



## **Always consult a qualified technician**

Shaft and bearing disassembly in the field is not recommended. These operations should be performed only in a properly equipped shop by qualified personnel.

Shaft and bearing disassembly in the field is not recommended. These operations should be performed only in a properly equipped shop by qualified personnel.

Remove the bearing housing drain plug and drain the lubricant. Clean and reinstall the drain plug. Disengage the hardware and slide the bearing cap and oil seal off the shaft. Remove the bearing cap gasket, and press the oil seal from the bearing cap.

Place a block of wood against the impeller end of the shaft and tap the shaft and assembled bearings from the bearing housing. Pry or press the oil seals from the bearing housing.

After removing the shaft and bearings, clean and inspect the bearings **in place** as follows.



## **Clean and inspect your bearings in place**

To prevent damage during removal from the shaft, it is recommended that bearings be cleaned and inspected in place. It is strongly recommended that the bearings be replaced any time the shaft and bearings are removed.

Clean the bearing housing, shaft and all component parts (except the bearings) with a soft cloth soaked in cleaning solvent. Inspect the parts for wear or damage and replace as necessary.



## **Always clean in a well-ventilated area**

Most cleaning solvents are toxic and flammable. Use them only in a well-ventilated area free from excessive heat, sparks, and flame. Read and follow all precautions printed on solvent containers.

Clean the bearings thoroughly in fresh cleaning solvent. Dry the bearings with filtered compressed air and coat with light oil.



### **Keep bearings clean**

Bearings must be kept free of all dirt and foreign material. Failure to do so will greatly shorten bearing life. **Do not** spin dry bearings. This may scratch the balls or races and cause premature bearing failure.

Rotate the bearings by hand to check for roughness or binding and inspect the bearing balls. If rotation is rough or the bearing balls are discolored, replace the bearings.

The bearing tolerances provide a tight press fit onto the shaft and a snug slip fit into the bearing housing. Replace the bearings, shaft, or bearing housing if the proper bearing fit is not achieved.

If bearing replacement is required, remove the out board bearing snap ring, and use a bearing puller to remove the bearings from the shaft.

## **Shaft & bearing reassembly & installation**

Clean the bearing housing, shaft and all component parts (except the bearings) with a soft cloth soaked in cleaning solvent. Inspect the parts for wear or damage as necessary.



### **Always clean in a well-ventilated area**

Most cleaning solvents are toxic and flammable. Use them only in a well ventilated area free from excessive heat, sparks, and flame. Read and follow all precautions printed on solvent containers.

Inspect the shaft for distortion, nicks or scratches, or for thread damage on the impeller end. Dress small nicks and burrs with a fine file or emery cloth. Replace the shaft if it's defective.

Position the inboard oil seal in the bearing housing bore with the lip positioned. Press the oil seal into the housing until the face is just flush with the counterbored surface toward the inside of the housing.



### **Clean and inspect your bearings in place**

To prevent damage during removal from the shaft, it is recommended that bearings be cleaned and inspected in place. It is strongly recommended that the bearings be replaced any time the shaft and bearings are removed.

#### **Note**

Position the outboard bearing on the shaft with the integral retaining ring on the bearing OD toward the drive end of the shaft.

The bearings may be heated to ease installation. An induction heater, hot oil bath, electric oven, or hot plate may be used to heat the bearings. Bearings should never be heated with a direct flame or directly on a hot plate.

#### **Note**

If a hot oil bath is used to heat the bearings, both the oil and the container must be **absolutely** clean. If the oil has been previously used, it must be **thoroughly** filtered.

Heat the bearings to a uniform temperature no higher than 250° F (120° C), and slide the bearings onto the shaft, one at a time, until they are fully seated. This should be done quickly, in one continuous motion, to prevent the bearings from cooling and sticking on the shaft.

After the bearings have been installed and allowed to cool, check to ensure that they have not moved away from the shaft shoulders in shrinking. If movement has occurred, use a suitable sized sleeve and a press to reposition the bearings against the shaft shoulders.

If heating the bearings is not practical, use a suitable sized sleeve, and an arbor (or hydraulic) press to install the bearings on the shaft.

Position the inboard oil seal in the bearing housing bore with the lip positioned. Press the oil seal into the housing until the face is just flush with the counterbored surface toward the inside of the housing.



### **Clean and inspect your bearings in place**

To prevent damage during removal from the shaft, it is recommended that bearings be cleaned and inspected in place. It is strongly recommended that the bearings be replaced any time the shaft and bearings are removed.

#### **Note**

Position the outboard bearing on the shaft with the integral retaining ring on the bearing O.D. toward the drive end of the shaft.

The bearings may be heated to ease installation. An induction heater, hot oil bath, electric oven, or hot plate may be used to heat the bearings. Bearings should never be heated with a direct flame or directly on a hot plate.

#### **Note**

If a hot oil bath is used to heat the bearings, both the oil and the container must be **absolutely** clean. If the oil has been previously used, it must be **thoroughly** filtered.

Heat the bearings to a uniform temperature no higher than 250° F (120° C), and slide the bearings onto the shaft, one at a time, until they are fully seated. This should be done quickly, in one continuous motion, to prevent the bearings from cooling and sticking on the shaft.

After the bearings have been installed and allowed to cool, check to ensure that they have not moved away from the shaft shoulders in shrinking. If movement has occurred, use a suitable sized sleeve and a press to reposition the bearings against the shaft shoulders.

If heating the bearings is not practical, use a suitable sized sleeve, and an arbor (or hydraulic) press to install the bearings on the shaft.



## Be careful when securing the outboard bearing

When installing the bearings onto the shaft, never press or hit against the outer race, balls, or ball cage. Press only on the inner race. Secure the outboard bearing on the shaft with the bearing snap ring.

It is recommended that a sleeve be positioned against the inboard oil seal (SB) to prevent the lip of the oil seal from rolling as the shaft and bearings are installed in the bearing housing. The O.D. of the sleeve should be just smaller than the bearing housing bore, while the I.D. of the sleeve should be just larger than the O.D. of the lip seal area of the shaft.

With the lip seal sleeve in place, lubricate the lip seal area of the shaft. and slide the shaft and as sembled bearings into the bearing housing until the retaining ring on the outboard bearing seats against the bearing housing. Remove the lip seal sleeve.



## Avoid damaging the balls or ball cage

When installing the shaft and bearings into the bearing bore, push against the outer race. Never hit the balls or ball cage.

Position the inboard oil seal on the lubricated shaft with the lip positioned. Press the oil seal into the bearing housing until the face of the seal is just flush with the machined surface on the bearing housing.

Press the outboard oil seal into the bearing cap with the lip positioned. Replace the bearing cap gasket, and secure the bearing cap with the hardware. Be careful not to damage the oil seal lip on the shaft keyway.

Lubricate the bearing housing as indicated in **Lubrication**.

## Seal installation

Clean the seal cavity and shaft with a cloth soaked in fresh cleaning solvent. Inspect the stationary seat bore in the seal plate for dirt, nicks and burrs, and remove any that exist. The stationary seat bore must be completely clean before installing the seal.



### Always clean in a well-ventilated area

Most cleaning solvents are toxic and flammable. Use them only in a well-ventilated area free from excessive heat, sparks, and flame. Read and follow all precautions printed on solvent containers.

Clean the seal cavity and shaft with a cloth soaked in fresh cleaning solvent. Inspect the stationary seat bore in the seal plate for dirt, nicks and burrs, and remove any that exist. The stationary seat bore must be completely clean before installing the seal.



### When to install a new seal assembly

A new seal assembly should be installed **any time** the old seal is removed from the pump. Wear patterns on the finished faces cannot be realigned during reassembly. Reusing an old seal could result in premature failure.

To ease installation of the seal, lubricate the shaft sleeve O-ring and the external stationary seat O-ring with a very small amount of light lubricating oil. See **Figure 10** for seal part identification.



### Do not use at excessively hot temperatures

This seal is not designed for operation at temperatures above 160° F (71° C). Do not use at higher operating temperatures.



**Figure 10**

**Cartridge Seal Assembly**

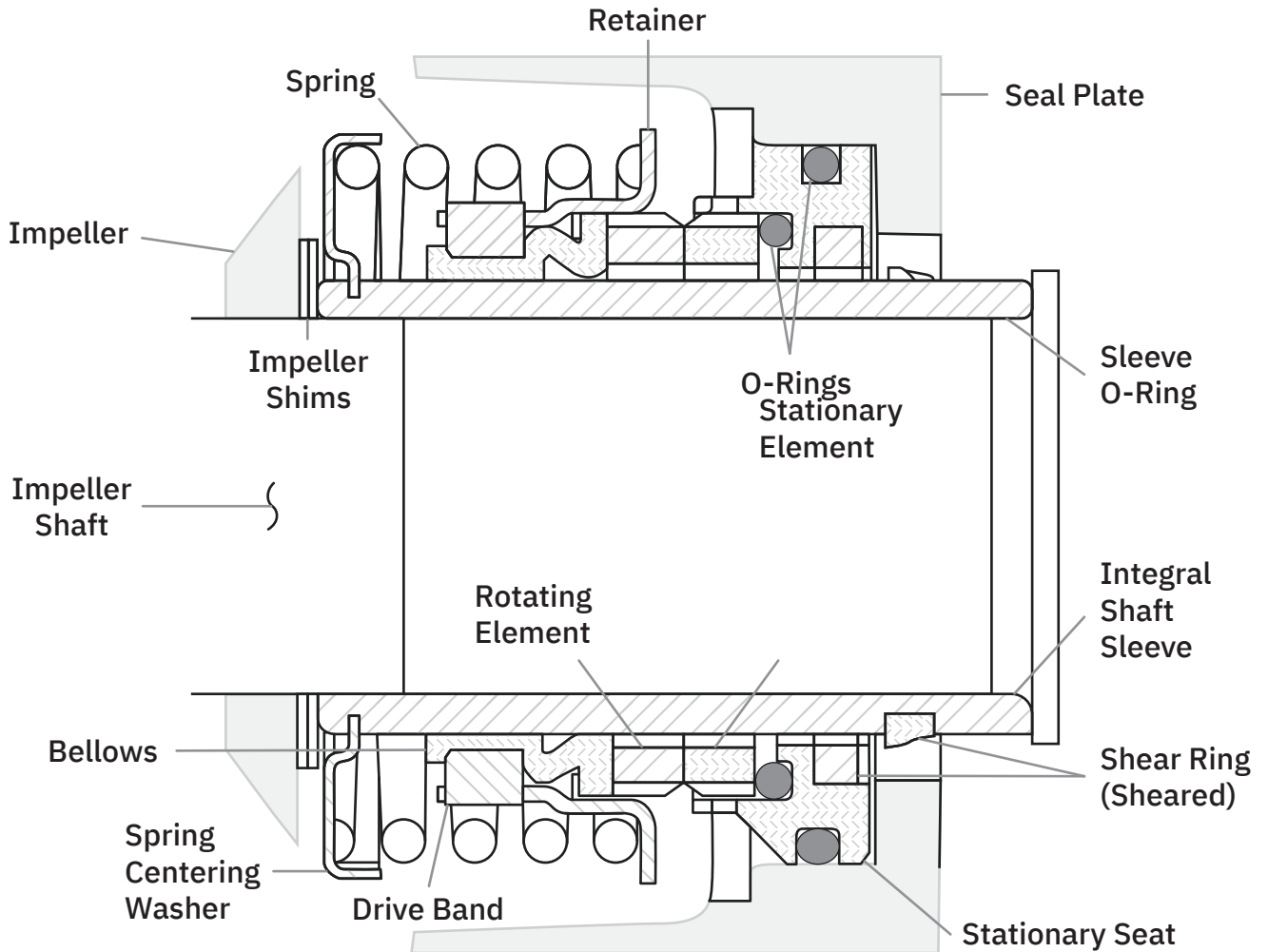

If the seal plate was removed, install the seal plate gasket. Position the seal plate over the shaft and secure it to the bearing housing with the hardware. Install the bearing housing O-ring and lubricate it with light grease. To prevent damaging the shaft sleeve O-ring on the shaft threads, stretch the O-ring over a piece of tubing just a little larger than the threads on the shaft. Slide the tube over the shaft threads, then slide the O-ring off the tube and onto the shaft. Remove the tube, and continue to slide the O-ring down the shaft until it seats against the shaft shoulder.

When installing a new cartridge seal assembly, remove the seal from the container, and, if so equipped, remove the mylar storage tabs from between the seal faces.



## Remove storage tabs before seal installation

Some new cartridge seal assemblies are equipped with mylar storage tabs between the seal faces. These storage tabs must be removed before installing the seal.

Lubricate the external stationary seat O-ring with light oil. Slide the seal assembly onto the shaft until the external stationary seat O-ring engages the bore in the seal plate.

Clean and inspect the impeller as described in **Impeller Installation and Adjustment**. Install the full set of impeller shims provided with the seal, and screw the impeller onto the shaft until it is seated against the seal (**see Figure 11**).

**Figure 11**

### Seal Partially Installed

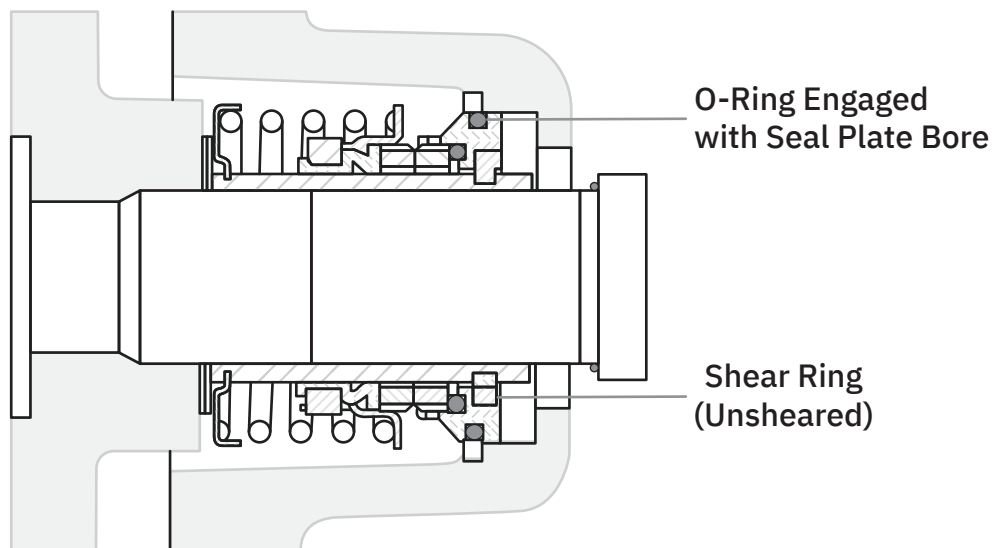

Continue to screw the impeller onto the shaft. This will press the stationary seat into the seal plate bore.

### Note

A firm resistance will be felt as the impeller presses the stationary seat into the seal plate bore.

**Figure 12**

**Seal Fully Installed**

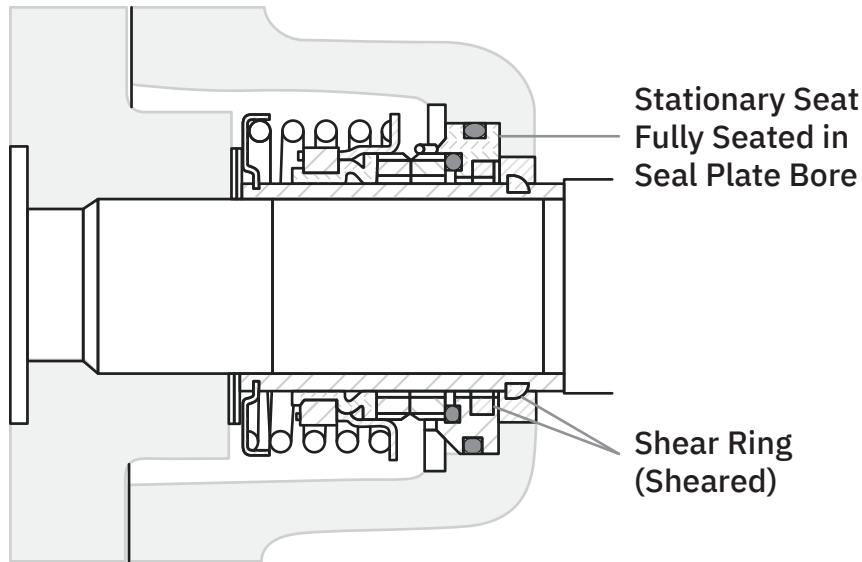

As the stationary seat becomes fully seated, the seal spring compresses, and the shaft sleeve will break the nylon shear ring. This allows the sleeve to slide down the shaft until seated against the shaft shoulder. Continue to screw the impeller onto the shaft until the impeller, shims, and sleeve are fully seated against the shaft shoulder (**see Figure 12**).

Measure the impeller-to-seal plate clearance, and remove impeller adjusting shims to obtain the proper clearance as described in Impeller Installation and Adjustment.

If necessary to reuse an old seal in an emergency, carefully separate the rotating and stationary seal faces from the bellows retainer and stationary seat.



**When to install a new seal assembly**

A new seal assembly should be installed any time the old seal is removed from the pump. Wear patterns on the finished faces cannot be realigned during reassembly. Reusing an old seal could result in premature failure.

Handle the seal parts with extreme care to prevent damage. Be careful not to contaminate

precision finished faces; even fingerprints on the faces can shorten seal life. If necessary, clean the faces with a non-oil based solvent and a clean, lint-free tissue. Wipe **lightly** in a concentric pattern to avoid scratching the faces.

**Carefully** wash all metallic parts in fresh cleaning solvent and allow to dry thoroughly.



### **Considerations if reusing an old seal**

**Do not** attempt to separate the rotating portion of the seal from the shaft sleeve when reusing an old seal. The rubber bellows will adhere to the sleeve during use, and attempting to separate them could damage the bellows.

Inspect the seal components for wear, scoring, grooves, and other damage that might cause leakage. Inspect the integral shaft sleeve for nicks or cuts on either end. If any components are worn, or the sleeve is damaged, replace the complete seal; never mix old and new seal parts.

Install the stationary seal element in the stationary seat. Press this stationary subassembly into the seal plate bore until it seats squarely against the bore shoulder. A push tube made from a piece of plastic pipe would aid this installation. The I.D. of the pipe should be slightly larger than the O.D. of the shaft sleeve.

Slide the rotating portion of the seal (consisting of the integral shaft sleeve, spring centering washer, spring, bellows and retainer, and rotating element) onto the shaft until the seal faces contact.

Proceed with **Impeller Installation and Adjustment**.

## **Impeller installation**

Inspect the impeller, and replace it if cracked or badly worn. Inspect the impeller and shaft threads for dirt or damage, and clean or dress the threads as required.



## Only install clean shaft and impeller threads

The shaft and impeller threads must be completely clean before reinstalling the impeller. Even the slightest amount of dirt on the threads can cause the impeller to seize fo the shaft, making future removal difficult or impossible without damage to the impeller or shaft.

Install the same thickness of impeller adjusting shims as previously removed. Apply 'Never Seez' or equivalent to the shaft threads and screw the impeller onto the shaft until tight.

### Note

At the slightest sign of binding, immediately back the impeller off, and check the threads for dirt. **Do not** try to force the impeller onto the shaft.

A clearance of .025 to .040 inch (0,64 to 1,02 mm) between the impeller and the seal plate is recommended for maximum pump efficiency. Measure this clearance, and add or remove impeller adjusting shims as required.

### Note

If the rotating assembly has been installed in the pump casing, this clearance may be measured by reaching through the priming port with a teeter gauge.

Proceed with **Rotating Assembly Installation** before installing the impeller capscrew and washer. The rotating assembly must be installed in the pump casing in order to torque the impeller capscrew.

After the rotating assembly is installed in the pump casing, coat the threads of the impeller capscrew with 'Never-Seez' or equivalent compound, and install the impeller washer and capscrew; torque the capscrew to 90 ft. lbs. (1080 in. lbs. or 12,4 m. kg.).

## Rotating assembly installation

### Note

If the pump has been completely disassembled, it is recommended that the suction check valve and back cover assembly be reinstalled at this point. The back cover assembly must be in place to adjust the impeller face clearance.

Install the bearing housing O-ring and lubricate it with light grease. Ease the rotating assembly into the pump casing using the installation tool. **Be careful** not to damage the O-ring.

Install the four sets of rotating assembly adjusting shims using the same thickness as previously removed. Secure the rotating assembly to the pump casing with the hardware.

To set the impeller and wear plate clearance refer to the **Back Cover Installation And Adjustment**.

## Suction check valve installation

Inspect the check valve assembly, and replace it if badly worn.

### Note

The check valve assembly must be replaced as a complete unit. Individual parts are not sold separately.

Reach through the back cover opening with the check valve and position the check valve adaptor in the mounting slot in the suction flange. Align the adaptor with the flange hole, and secure the assembly with the check valve pin.

### Note

If the suction or discharge flanges were removed, replace the respective gaskets, apply 'Permatex Aviation No. 3 Form-A-Gasket' or equivalent compound to the mating surfaces, and secure them to the pump casing with the attaching hardware.

## Back cover installation & adjustment

If the wear plate was removed for replacement, carefully center it on the back cover and secure it with the hardware. The wear plate must be concentric to prevent binding when the back cover is installed.

Clearance between the impeller and wear plate is adjusted using four adjusting screws and locking collars. There are 18 detents on the I.D. of each locking collar. Indexing the collars one detent on the adjusting screws represents approximately .005 inch (0,13 mm) of wear

plate clearance. The recommended clearance between the wear plate and the impeller is .010 to .020 inch (0,25 to 0,50 mm).

**Figure 13**

### Installing & Adjusting Back Cover

Use two remaining adjusting screws and locking collars to set face clearance

Use two opposing nuts to press back cover into pump casing

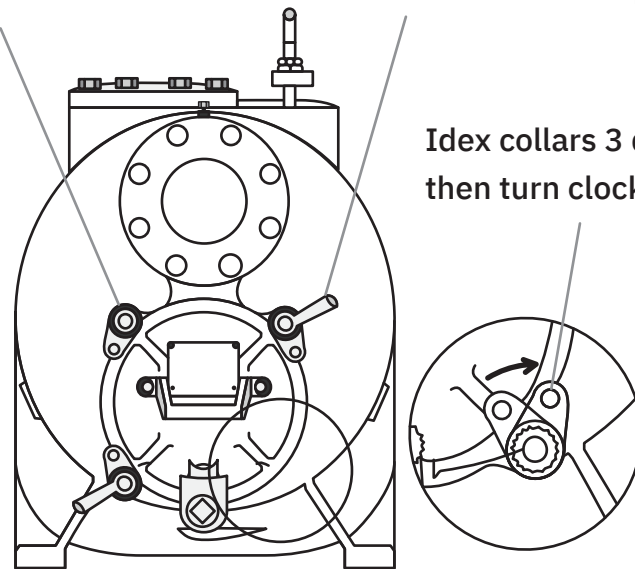

Index collars 3 detents counter-clockwise, then turn clockwise until screw holes align

Replace the back cover O-rings, and lubricate them with a generous amount of No. 2 grease. Clean any scale or debris from the contacting surfaces in the pump casing that might interfere or prevent a good seal with the back cover.

Screw the four adjusting screws into the tapped holes in the back cover plate until they are **just flush** with the machined surface on the backside of the cover plate.

Align the back cover plate over the studs and slide it into the pump casing. Use two nuts on diagonally opposing studs to press the back cover into the pump casing until the wear plate **just touches** the impeller when the shaft is turned by hand. **Tighten the nuts evenly to avoid binding.**

With the wear plate just touching the impeller, turn the two free adjusting screws until they

engage the pump casing. Position the locking collars over the adjusting screws so the holes in the collars for the locking screws align approximately with the holes in the cover plate.

Loosen the nuts used to press the back cover into the pump casing one full turn.

Pull the collars off the adjusting screws, index them three detents counterclockwise, and reinstall the collars on the adjusting screws. Use the collars to turn the adjusting screws clockwise until the holes in the locking collars realign with the tapped screw holes in the back cover plate. Secure the locking collars to the back cover plate with the hardware. Install the two remaining nuts snugly against the adjusting screws.

Remove the first two nuts from their studs. Turn the adjusting screws clockwise until they engage the pump casing. Install the locking collars and hardware. Reinstall the hand nuts.

Be sure the wear plate does not scrape against the impeller.

Over time it may be necessary to repeat the adjustment process to compensate for normal wear between the impeller and wear plate. When all of the adjustment has been used on the back cover side of the pump, an additional 0.125 inch (3,2 mm) of adjustment may be obtained by removing the rotating assembly adjusting shims.

Allow an installed pump to completely cool before draining liquid from the pump casing. Remove the back cover. Remove the rotating assembly adjusting shims. then reinstall the hardware securing the rotating assembly to the pump casing. Perform the back cover adjustment procedure described above to obtain the proper face clearance.

## **Pressure relief valve maintenance**

The back cover is equipped with a pressure relief valve to provide additional safety for the pump and operator (refer to Liquid Temperature And Overheating in Operation).

It is recommended that the pressure relief valve assembly be replaced at each overhaul. or any time the pump overheats and activates the valve. Never replace this valve with a substitute which has not been specified or provided by the Phantom Sales Group.



Periodically, the valve should be removed for inspection and cleaning. When reinstalling the relief valve, apply 'Loctite Pipe Sealant With Teflon No. 592', or equivalent compound, on the relief valve threads. Position the valve with the discharge port pointing down.

## Final pump assembly

Install the shaft key and reconnect the power source. Be sure to install any guards used over the rotating members.



### **Never operate the pump without the guard**

Do not operate the pump without the guards in place over the rotating parts. Exposed rotating parts can catch clothing, fingers, or tools, causing severe injury to personnel.

Install the suction and discharge lines and open all valves. Make certain that all piping connections are tight, properly supported and secure.

Be sure the pump and power source have been properly lubricated, see **Lubrication** section. Remove the fill cover assembly and fill the pump casing with clean liquid. Reinstall the fill cover and tighten it. Refer to **Operation**, Section C, before putting the pump back into service.

## Lubrication

### Seal assembly

Before starting the pump, remove the vented plug and fill the seal cavity with approximately 64 ounces (1,9 liter) SAE No. 30 non-detergent oil to the middle of the sight gauge and maintain it at the middle of the gauge. Clean and reinstall the vented plug. Maintain the oil at this level.

### Note

The white reflector in the sight gauge must be positioned horizontally to provide proper drainage.

## Bearings

The bearing housing was fully lubricated when shipped from the factory. Check the oil level regularly through the sight gauge and maintain it at the middle of the gauge. When lubrication is required, add SAE No. 30 non-detergent-oil through the hole for the air vent. Do not over-lubricate. Over-lubrication can cause the bearings to overheat, resulting in premature bearing failure.

### Note

The white reflector in the sight gauge must be positioned horizontally to provide proper drainage.

Under normal conditions, drain the bearing housing once each year and refill with approximately 10 ounces (0,3 liter) clean oil. Change the oil more frequently if the pump is operated continuously or installed in an environment with rapid temperature change.



### **Be aware of rust or moisture condensation**

Monitor the condition of the bearing lubricant regularly for evidence of rust or moisture condensation. This is especially important in areas where variable hot and cold temperatures are common.

For cold weather operation consult the factory or a lubricant supplier for the recommended grade of oil.

## Power source

Consult the literature supplied with the power source, or contact your local power source representative.

## Bearings

The bearing housing was fully lubricated when shipped from the factory. Check the oil level regularly through the sight gauge and maintain it at the middle of the gauge. When lubrication is required, add SAE No. 30 non-detergent-oil through the hole for the air vent. Do not over-lubricate. Over-lubrication can cause the bearings to overheat, resulting in premature bearing failure.

### Note

The white reflector in the sight gauge must be positioned horizontally to provide proper drainage.

Under normal conditions, drain the bearing housing once each year and refill with approximately 10 ounces (0,3 liter) clean oil. Change the oil more frequently if the pump is operated continuously or installed in an environment with rapid temperature change.



### **Be aware of rust or moisture condensation**

Monitor the condition of the bearing lubricant regularly for evidence of rust or moisture condensation. This is especially important in areas where variable hot and cold temperatures are common.

For cold weather operation consult the factory or a lubricant supplier for the recommended grade of oil.

## Power source

Consult the literature supplied with the power source, or contact your local power source representative.

# Troubleshooting

**Review all Safety information first**

Follow the instructions on all tags, labels and decals attached to the pump.



## Before attempting to open or service the pump

1. Familiarize yourself with this manual.
2. Lock out or disconnect the power source to ensure that the pump will remain inoperative.
3. Allow the pump to completely cool if overheated.
4. Check the temperature before opening any covers, plates, or plugs.
5. Close the suction and discharge valves.
6. Vent the pump slowly and cautiously.
7. Drain the pump.

Problem	Possible Cause	Probable Remedy
<p><b>Pump fails to prime</b></p>	<ol style="list-style-type: none"> <li>1. Not enough liquid in casing.</li> <li>2. Suction check valve contaminated or damaged.</li> <li>3. Air leak in suction line.</li> <li>4. Lining of suction hose collapsed.</li> <li>5. Leaking or worn seal or pump gasket.</li> <li>6. Suction lift or discharge head too high.</li> <li>7. Strainer clogged.</li> </ol>	<ol style="list-style-type: none"> <li>1. Add liquid to casing. See Priming.</li> <li>2. Clean or replace check valve.</li> <li>3. Correct leak.</li> <li>4. Replace suction hose.</li> <li>5. Check pump vacuum, replace leaking or worn seal or gasket.</li> <li>6. Check piping installation and install bypass line if needed. See Installation.</li> <li>7. Check strainer and clean if necessary.</li> </ol>
<p><b>Pump stops or fails to deliver rated flow or pressure</b></p>	<ol style="list-style-type: none"> <li>1. Air leak in suction line.</li> <li>2. Lining of suction hose collapsed.</li> <li>3. Leaking or worn seal or pump gasket.</li> <li>4. Strainer clogged.</li> <li>5. Suction intake not submerged at proper level or sump too small.</li> </ol>	<ol style="list-style-type: none"> <li>1. Correct leak.</li> <li>2. Replace suction hose.</li> <li>3. Check pump vacuum. Replace leaking or worn seal or gasket.</li> <li>4. Check strainer and clean if necessary.</li> <li>5. Check installation and correct submergence as needed.</li> <li>6. Replace worn or damaged</li> </ol>

Problem	Possible Cause	Probable Remedy
<p><b>Pump stops or fails to deliver rated flow or pressure</b></p>	<ol style="list-style-type: none"> <li>1. Impeller or other wearing parts worn or damaged.</li> <li>2. Impeller clogged.</li> <li>3. Pump speed too slow.</li> <li>4. Discharge head too high.</li> <li>5. Suction lift too high.</li> </ol>	<ol style="list-style-type: none"> <li>1. parts. Check that impeller is properly centered and rotates freely.</li> <li>2. Free impeller of debris.</li> <li>3. Check driver output; check belts or couplings for slippage.</li> <li>4. Install bypass line.</li> <li>5. Measure lift w/vacuum gauge. Reduce lift and/or friction losses in suction line.</li> </ol>
<p><b>Pump requires too much power</b></p>	<ol style="list-style-type: none"> <li>1. Pump speed too high.</li> <li>2. Discharge head too low.</li> <li>3. Liquid solution too thick.</li> <li>4. Bearing(s) frozen.</li> </ol>	<ol style="list-style-type: none"> <li>1. Check driver output; check that sheaves or couplings are correctly sized.</li> <li>2. Adjust discharge valve.</li> <li>3. Dilute if possible.</li> <li>4. Disassemble pump and check bearing(s).</li> </ol>
<p><b>Pump clogs frequently</b></p>	<ol style="list-style-type: none"> <li>1. Liquid solution too thick.</li> <li>2. Discharge flow too slow.</li> <li>3. Suction check valve or foot valve clogged or binding.</li> </ol>	<ol style="list-style-type: none"> <li>1. Dilute if possible.</li> <li>2. Open discharge valve fully to increase flow rate, and run power source at maximum governed speed.</li> <li>3. Clean valve.</li> </ol>
<p><b>Excessive noise</b></p>	<ol style="list-style-type: none"> <li>1. Cavitation in pump.</li> <li>2. Pumping entrained air.</li> <li>3. Pump or drive not securely mounted.</li> <li>4. Impeller clogged or damaged.</li> </ol>	<ol style="list-style-type: none"> <li>1. Reduce suction lift and/or friction losses in suction line. Record vacuum and pressure gauge readings and consult local representative or factory.</li> <li>2. Locate and eliminate source of air bubble.</li> <li>3. Secure mounting hardware.</li> <li>4. Clean out debris; replace damaged parts.</li> </ol>
<p><b>Bearings run too hot</b></p>	<ol style="list-style-type: none"> <li>1. Bearing temperature is high, but within limits.</li> <li>2. Low or incorrect lubricant.</li> <li>3. Suction and discharge lines not properly supported.</li> </ol>	<ol style="list-style-type: none"> <li>1. Check bearing temperature regularly to monitor any increase.</li> <li>2. Check proper type and level of lubricant.</li> </ol>

Problem	Possible Cause	Probable Remedy
Bearings run too hot	1. Drive misaligned.	1. Check piping installation for proper support. 2. Align drive properly.

## Preventative maintenance

Since pump applications are seldom identical, and pump wear is directly affected by such things as the abrasive qualities, pressure and temperature of the liquid being pumped, this section is intended only to provide general recommendations and practices for preventive maintenance. Regardless of the application however, following a routine preventive maintenance schedule will help assure trouble-free performance and long life from your Phantom pump. For specific questions concerning your application, contact your Phantom Sales distributor or the Phantom Sales Company.

Record keeping is an essential component of a good preventive maintenance program. Changes in suction and discharge gauge readings (if so equipped) between regularly scheduled inspections can indicate problems that can be corrected before system damage or catastrophic failure occurs. The appearance of wearing parts should also be documented at each inspection for comparison as well. Also, if records indicate that a certain part (such as the seal) fails at approximately the same duty cycle, the part can be checked and replaced before failure occurs, reducing unscheduled downtime.

For new applications, a first inspection of wearing parts at 250 hours will give insight into the wear rate for your particular application. Subsequent inspections should be performed at the intervals shown on the chart below. Critical applications should be inspected more frequently.

## Preventive maintenance schedule

Item	Service Interval*				
	Daily	Weekly	Monthly	Semi-Annually	Annually
General Condition (Temperature, Unusual Noises or Vibrations, Cracks, Leaks, Loose Hardware, Etc.)	I				
Pump Performance (Gauges, Speed, Flow)	I				
Bearing lubrication		I			R
Seal Lubrication (And Packing Adjustment, If So Equipped)		I			R
V-Belts (If So Equipped)			I		
Air Release Valve Plunger Rod (If So Equipped)			I	C	
Front Impeller Clearance (Wear Plate)				I	
Rear Impeller Clearance (Seal Plate)				I	
Check Valve					I
Pressure Relief Valve (If So Equipped)					C
Pump Driven Alignment					I
Shaft Deflection					I
Bearings					I
Bearings Housing					I
Piping					I
Driver Lubrication - See Mfgr's Literature					I

**Legend**

I = Inspect, Clean, Adjust, Repair or Replace as Necessary  
 C = Clean  
 R = Replace

\*Service interval based on an intermittent duty cycle equal to approximately 4000 hours annually. Adjust schedule as required for lower or higher duty cycles or extreme operating conditions.